

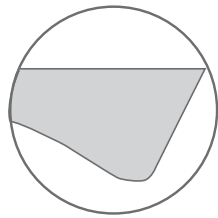

Duvet Covers

- **Closures:** These covers are available with standard zipper or Velcro closures
Options include:
 - Tie or flap top
 - Luxurious envelope
- **Edge:** Can be specified as knife, flange or welt



Knife

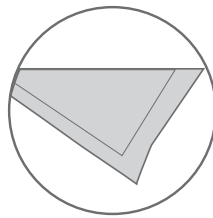

Flange

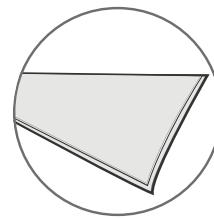

Welt

Yardage:

- 54" fabric requires 12 yards and is joined
- 126" fabric (or fabrics over 110") require 6 yards and are seamless on both face and underside
- When specifying flange or welted edges, add one yard of fabric (for either 54" or 126" wide material).

Duvet Inserts

- Continuous filament fiberfill of hypollergenic, siliconized, 100% virgin polyester
- The insert shell is made of preshrunk 70/30 poly/cotton, leak proof, washable fabric
- Fiber is pre-blended and garneted
- Also available is our Natural Down
- Standard fill weights are:

BED TYPE	DIMENSIONS	POLYESTER FIBERFILL	NATURAL DOWN
Twin	66" x 90"	33 oz.	26 oz.
Double	82" x 90"	40 oz.	28 oz.
Queen	90" x 90"	45 oz.	29.5 oz.
King	104" x 90"	50 oz.	33 oz.

Custom fill weights are also available.

A machine washable self-contained duvet style is also available. Consult the factory for more information.



Duvet Cover Design Options

Reverse Sham

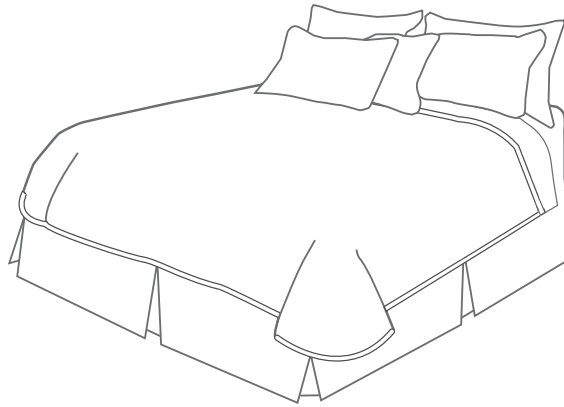
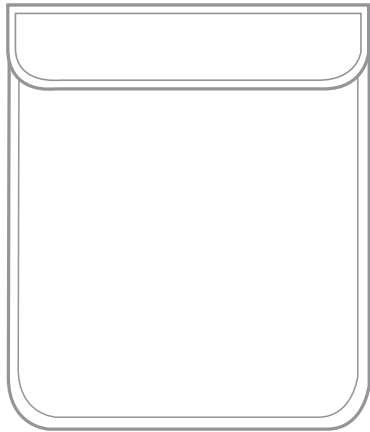

Reverse Sham with Accent Welt Edge

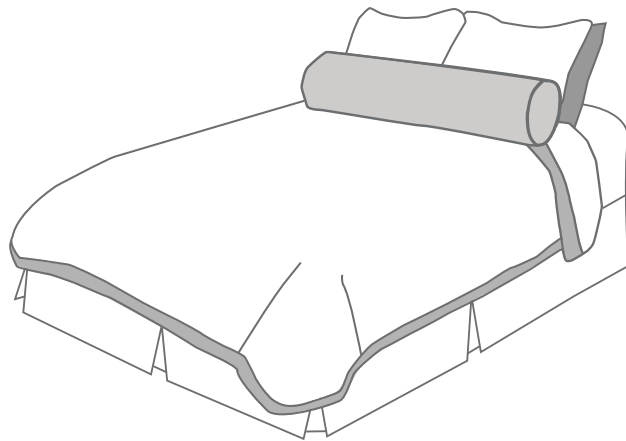
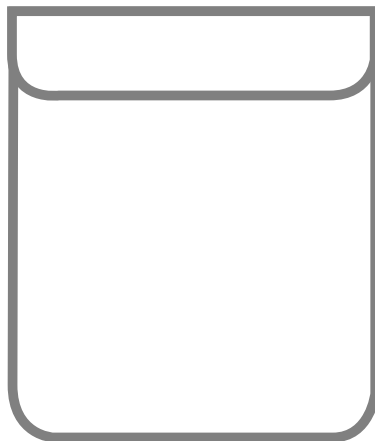

Accent Banded

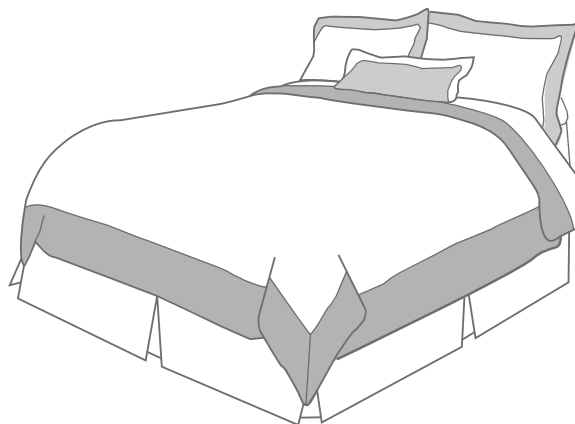

Bed Scarves



- A decorative accent placed over the duvet or bedspread. It is typically 20" - 25" wide and falls to the top of the bed skirt.
- Face and back can either be the same or contrasting fabrics.
- Edge detail can be knife edge, tape edge, welt or flange.
- Options:
 - Interlined
 - Continuous siliconized 100% virgin polyester
 - Any quilting pattern



Bed Wraps

- A flat draping bed cover that typically covers 50% to 65% of the entire bed and typically drops to the bed skirt.
- Face and back can either be the same or contrasting fabrics.
- Edge detail can be knife edge, tape edge, welt or flange.
- Options:
 - Interlined
 - Continuous siliconized 100% virgin polyester
 - Any quilting pattern

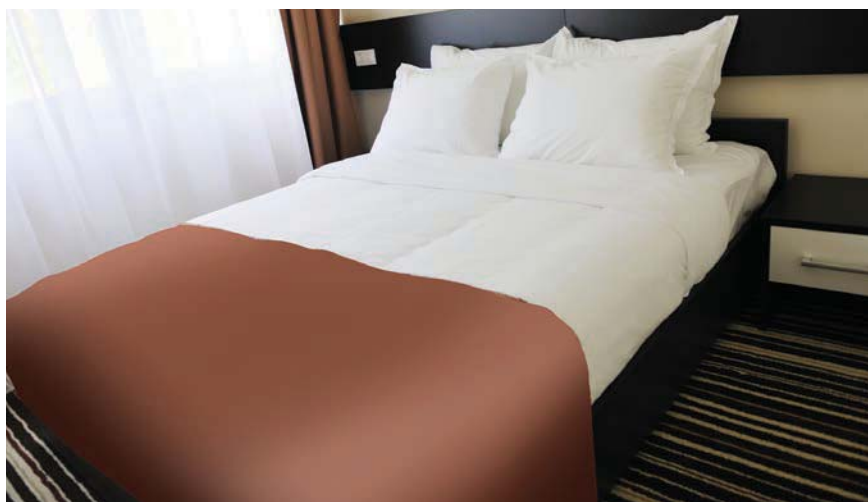

Bed Skirts

Decking: Manufactured using 70/30 polyester/cotton blend or 100% polyester (Fillion)

Lining: Optional lining is a 70/30 poly/cotton blend or 100% polyester

- Face fabric on lined bed skirts will have a 1" turn to the back side of the skirt
- Unlined bed skirts will have a double turned 1" lock-stitched hem

Platform Strip: All of County's bed skirts are manufactured with a 4" platform strip so the decking does not show if the mattress slips

- The 4" wide strip on all three sides is made from the same fabric as the skirt

Size: Width and length of box spring + the drop which is normally 13" – 14"
Drops should be calculated 1/2" above the floor

Bed Skirt Options

• Options available to help prevent or minimize slippage:

- Fitted Cap: A 4" wide strip of decking extending over the top of the bed and enclosing the top corners to minimize movement (slippage) of the skirt
- Elasticized Corners: A fitted sheet with elasticized corners holds the bed skirt in place
- Hugger: A fitted sheet with elasticized banding around the entire perimeter to reduce movement of the bed skirt
- Grippers: Non-slip triangular corner pads are sewn into the underside of the platform to prevent movement of the bed skirt

Bed Skirt with Elasticized Corners

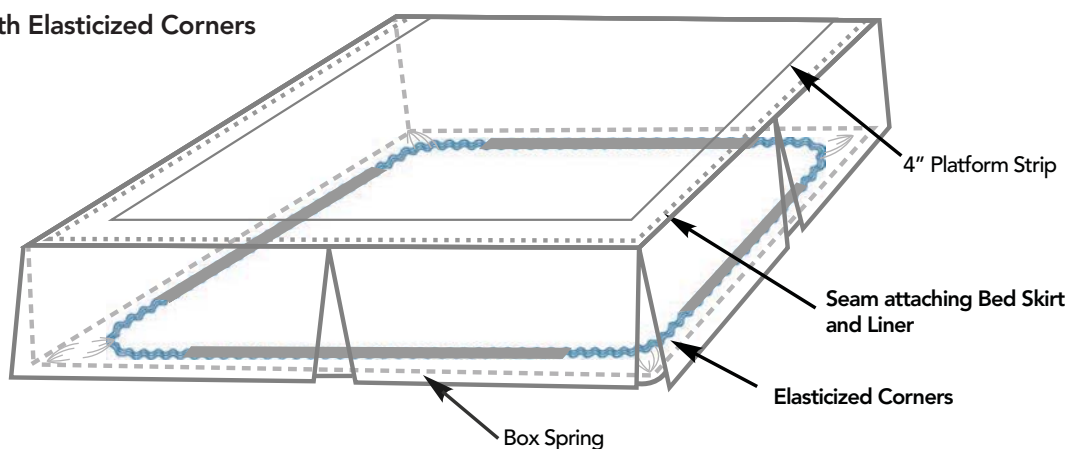

Partial view of underside of one elasticized corner

Bed Skirt Options

Bed Skirt Hugger

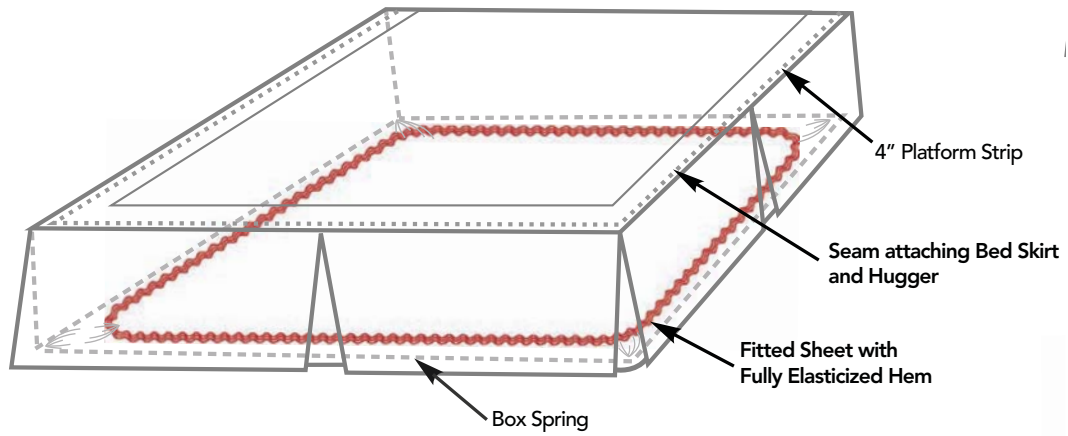

Partial view of fitted sheet with elasticized banding around the entire perimeter

Bed Skirt with Grippers

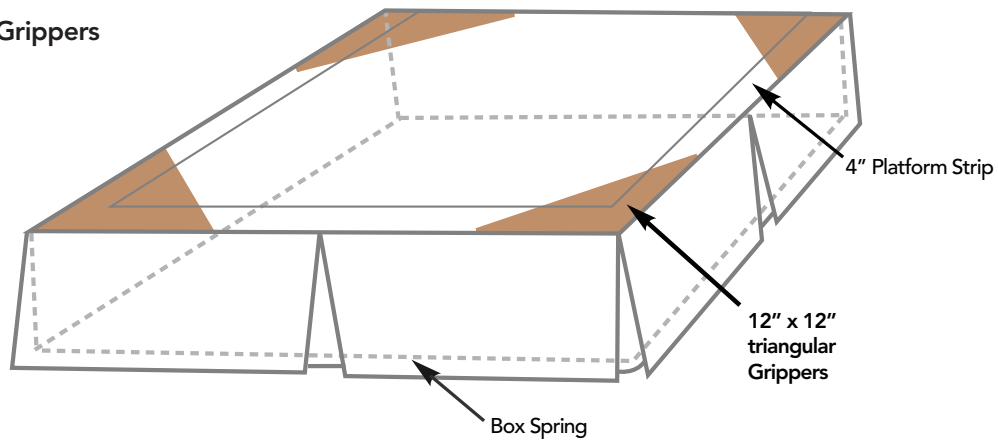

Standard Bed Skirt Styles

Shirred – Gathered on all three sides of the drop with 200% fullness (unless otherwise specified)

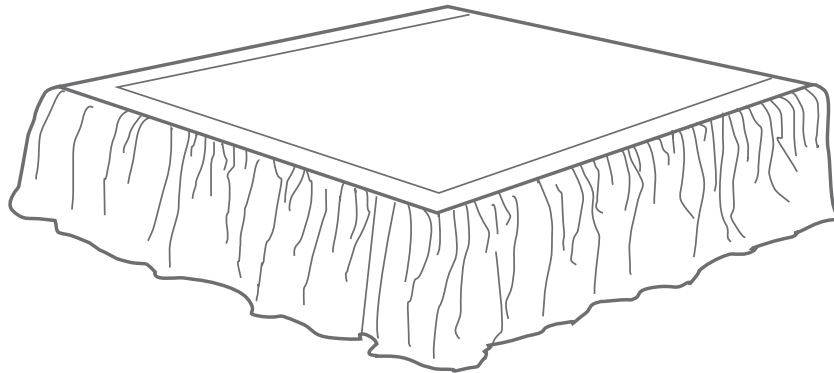

Tailored – 3 or 5 inverted pleats. Pleats are placed at the center of the three side drops and one each at the front corners.

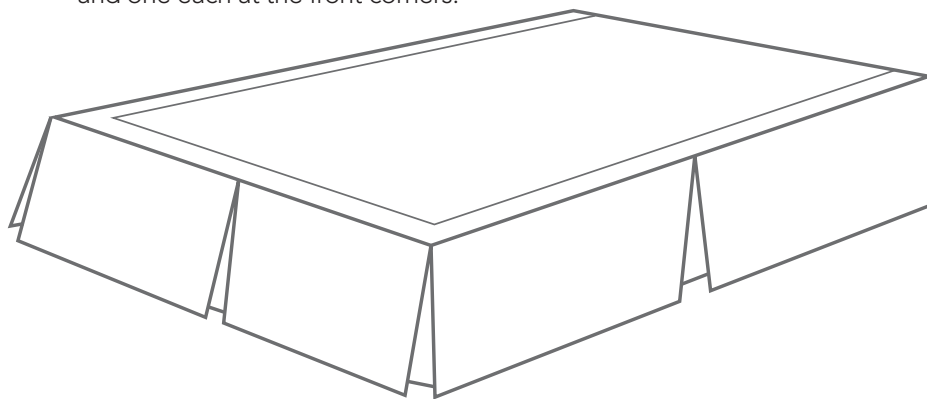

Box Pleated – Continuous inverted pleats on all three sides of the drop.
Pleat widths are 6", 8" or 10"

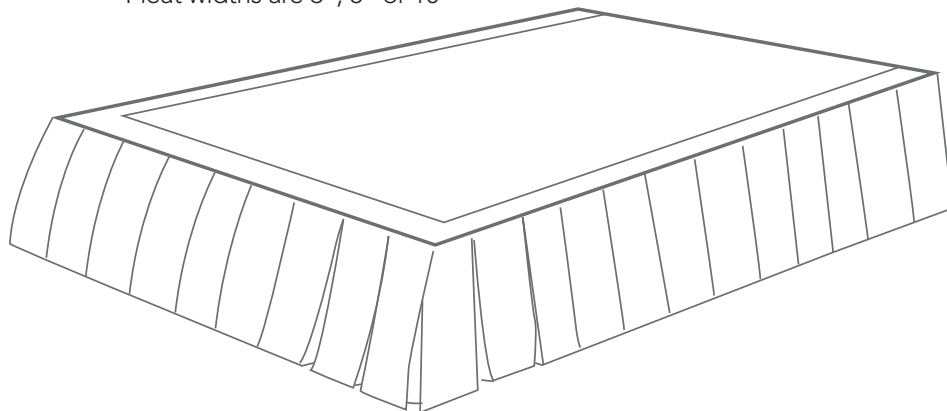

Corner Pleated - 2 inverted pleats at front corners.

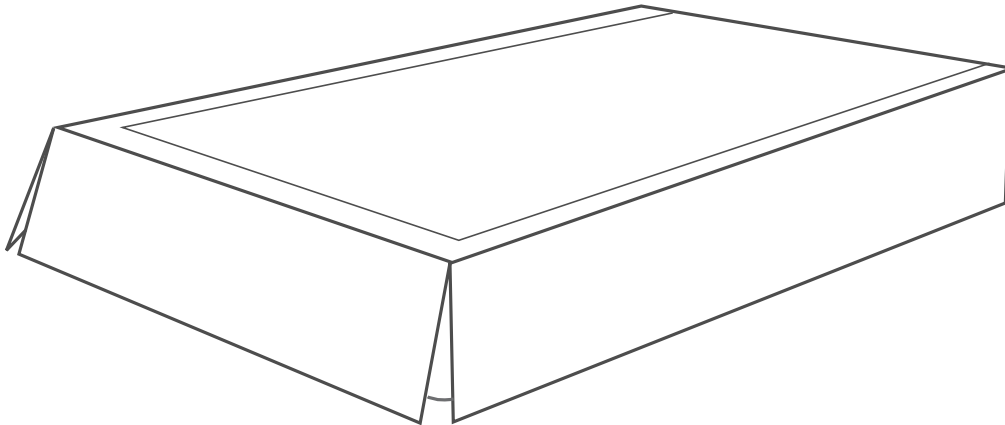

COM Yardage Requirements of Bed Skirts

SIZE		BED SKIRT STYLE					
Bed Type	Dimensions	Shirred	Tailored	Tailored w/ Accent Pleat	Corner Pleated	Corner Pleated w/ Accent Pleat	Box Pleated
		54" w	54" w	54" w	54" w	54" w	54" w
Twin	39" x 75" x 14"	4.00	4.00	5.25	3.75	4.50	6.25
Twin XL	39" x 80" x 14"	4.25	4.00	5.25	3.75	4.50	6.25
Double	54" x 75" x 14"	4.50	4.50	5.75	4.25	5.00	6.75
Double XL	54" x 80" x 14"	4.75	4.50	5.75	4.25	5.00	6.75
Queen	60" x 80" x 14"	4.75	4.50	5.75	4.25	5.00	6.75
Cal King	72" x 80" x 14"	5.25	5.00	6.25	4.75	5.50	7.25
Cal King Long	72" x 84" x 14"	5.25	5.00	6.25	4.75	5.50	7.25
Dual King	78" x 80" x 14"	5.25	5.00	6.25	4.75	5.50	7.25
Eastern King	76" x 80" x 14"	5.25	5.00	6.25	4.75	5.50	7.25

Note: Orientation of stripes and patterns in relation to how they are printed (vertical or horizontal) will affect COM yardage calculations



Standard Box Spring Covers

This form fitting fabric cover is an elegant solution that snugly fits over and conceals the entire box spring.

Top Decking: Manufactured using 70/30 polyester/cotton blend or optional 100% polyester (customer may specify preference).

Top Platform Strip: All of County's box spring covers are manufactured with a 4" platform strip so the decking does not show if the mattress slips.

The 4" wide strip on all three sides is made from the same fabric as the box spring cover.

Size: Width, length and height of box spring + 2" for ease of installation.

Classic-Zip Box Spring Covers

Zippered Closure: Rather than the fitted sheet style (in which the underside of the mattress is exposed) this is a full-enclosure method wherein the entire box spring is closely surrounded by fabric and, once the box spring is positioned inside, the opening along the bottom seam at the head of the bed can then be zipped closed. This location allows for the zipper to be hidden from guest view. The rest of the construction is the same as the standard style with decking and platform strip. The underside of the cover is made with the same decking material.

Top and Bottom Deckings: Manufactured using 70/30 polyester/cotton blend or optional 100% polyester (customer may specify preference).

Top and Bottom Platform Strips: 4" fabric strips in the same fabric as the box spring case are placed on all four sides on both the upper and underside of the case so the decking does not show if the mattress slips.

Size: Width, length and height of box spring + 2" for ease of installation.

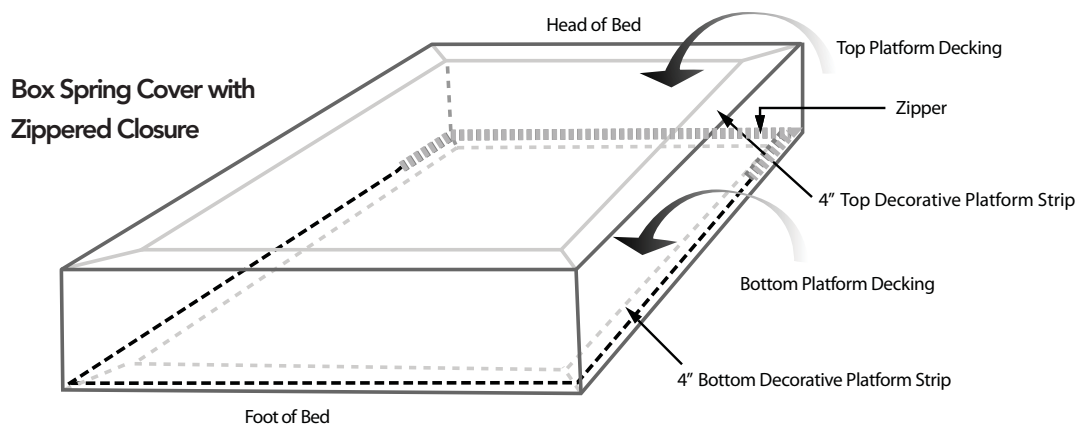

Both Standard and Classic-Zip styles are available with the following options:

- Tailored with pleats on sides and corners
- Flat Wrapped around all four sides
- Closed cap corners
- Quilted

Box Spring Covers



Standard Box Spring Cover



Detail of Corner of Standard Box Spring Cover



Underside view of Classic Zip Style



Underside view of Classic Zip Style showing the unzipped case with the Box Spring inside



Pillows, Bolsters and Shams

County fabricates an assortment bedding accessories in a variety of sizes and designs with many decorative edge treatments and details.



Throw Pillows

Closure: The standard is a machine-sewn closure but zippered closures are also available.

Fill: Each pillow is hand-filled with down or polyester fiberfill (*customer to specify*) to a medium density. Softer or firmer densities are available but must be specified.

Options: Decorative edgings such as welts, trims, braids and tassels; or center buttons.

Throw Pillow Styles

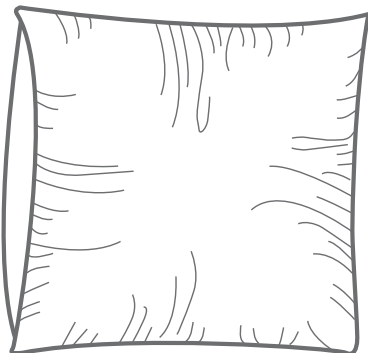

Knife Edge
Standard

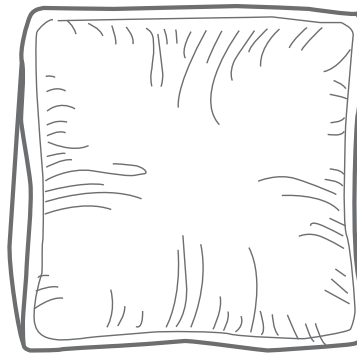

Knife Edge
Cord Edge

Throw Pillow Styles

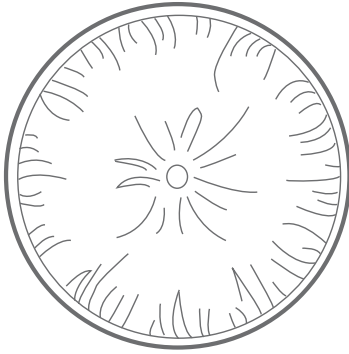

Cord Edge
w/ Button

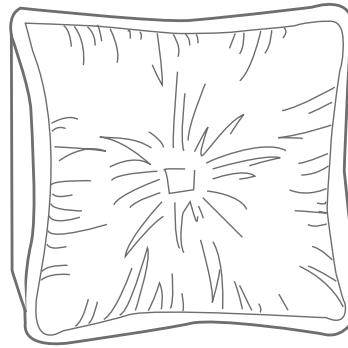

Cord Edge
w/ Square Button

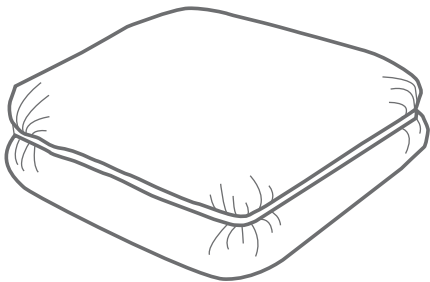

Turkish Corners

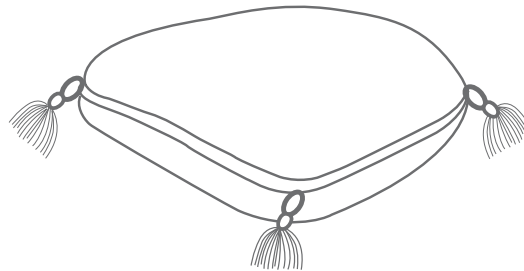

Tassled Corners

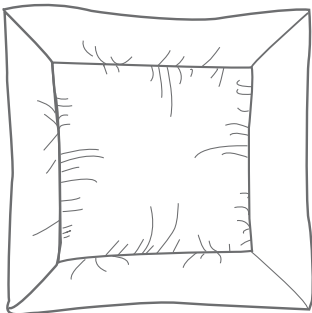

Mitered Flange

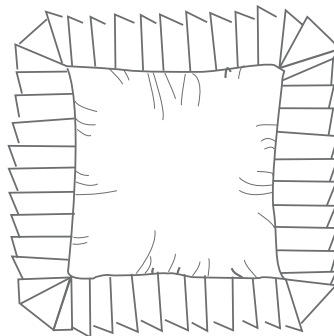

Ruffled

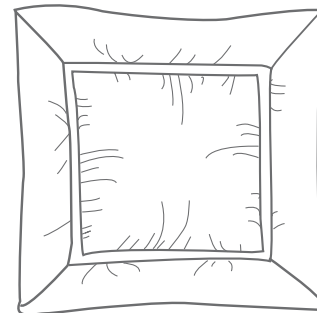

Mitered Flange
w/ Cord



COM Yardage Requirements for Pillows

STYLE	PILLOW SIZE					
	Up to & Including 15"	16" - 18"	19"- 21"	22"- 24"	25"- 27"	28"- 34"
KNIFE EDGE	.5	.75	.75	1.5	1.75	2
WELTED	.5	1.25	1.5	1.75	2	2.5
RUFFLED	1.25	1.5	1.75	2.25		
SHAPED CORNERS MOCK BOX HAREM TURKISH	1	1.5	2	2	2.25	2.5
SHIRRED BOX SUNBURST	1.5	1.75	2	2.25	2.5	
FLANGE	1.25	1.75	2	2.25	2.5	
BOX WELTED	1	1.5	1.75	2	2.5	

Bolsters



Detail of Bolster with contrasting side panel and welt and zippered closure

Closure: The standard is a machine-sewn closure but zippered closures are also available.

Fill: Each pillow is hand-filled with down, polyester fiberfill or foam (customer to specify) to a medium density. Softer or firmer densities are available but must be specified.

Options: Decorative edgings such as trims, braids and tassels; center buttons on ends; end panels can be specified with a contrasting secondary fabric.

Sizes: Typical cylindrical bolsters are available from 4" to 12" in diameter and in any specified length. Custom sizes and shapes are also available.

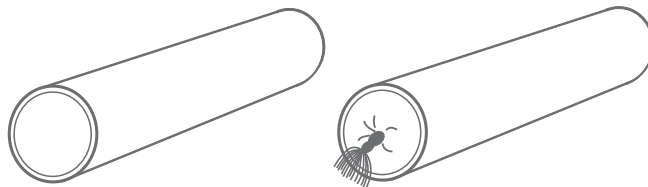

Pillow Shams

Standard pillow sizes: Full (27" x 21"), Queen (30" x 21"), King (36" x 21") and Euro (26" x 26").

Closure: The standard is a simple envelope closure. Zippers and Velcro are also available.

Edges: Welted, Knife edge and Flange

Welts: 1/4", 1/2" or 1" self-welt with closed edges.

Options: Decorative edgings such as trims, braids and tassels.
Front (and back) of sham can also be quilted.

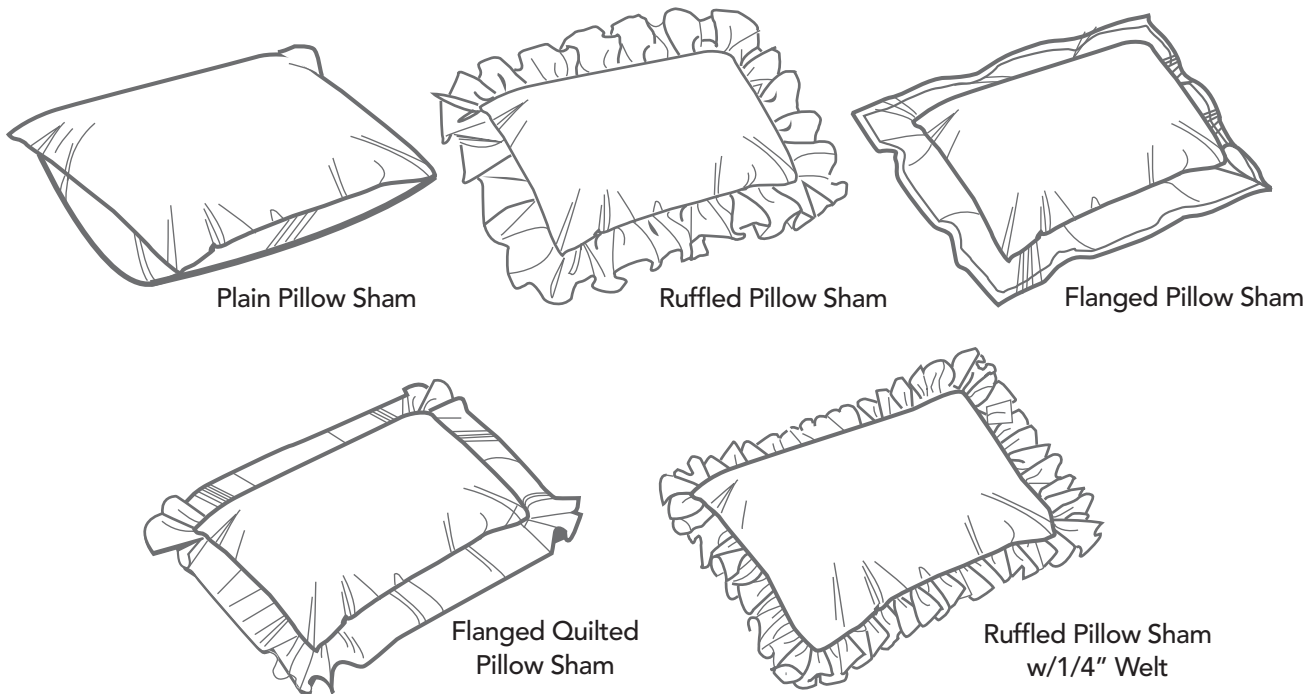

COM Yardage Requirements for Shams

For solid or print fabrics using envelope closure

SIZE	SHAM STYLE							
	Plain Knife	Welt	Flange	Welt & Flange	Ruffle	Ruffle & Welt	Box Pleat	Double Ruffle or Flange
Full – 27" x 21"	1.5	1.5	1.8	2	2.4	2.7	2.7	3.3
Queen – 30" x 21"	2	2	2.3	2.5	3.1	3.4	3.7	4.8
King – 36" x 21"	2	2	2.5	2.7	3.1	3.4	3.7	4.8
Full – 27" x 21"	1.75	2.25	2.2	2.5				

All yardages are estimated. Zipper and Velcro closures require slightly less yardage.
Consult factory for exact yardage quotation.



Headboards

County fabricates an assortment of fully upholstered headboards in all standard bed sizes. The core is constructed of plywood with foam or dacron padding. The headboards may be mounted on legs or on a wall cleat.

The contoured tops have single or double rolls that may be flat, shirred or pleated. Shirred Jumbo Cord can replace the contour roll top.

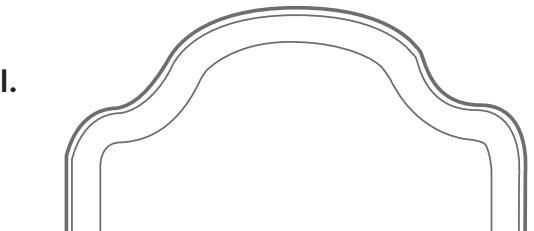
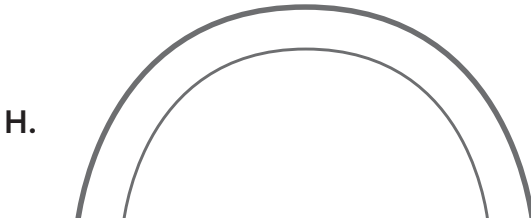
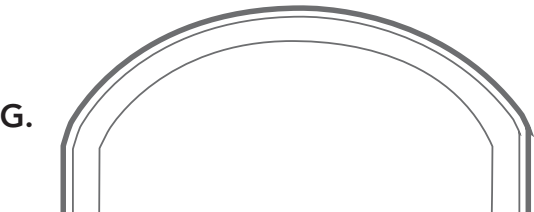
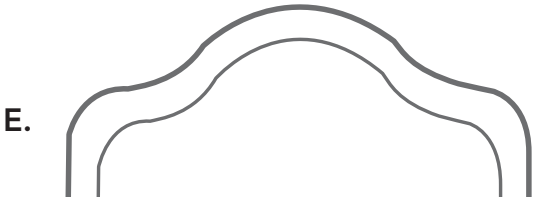
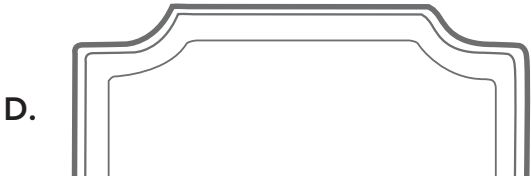

Headboards

Gathered Headboards:

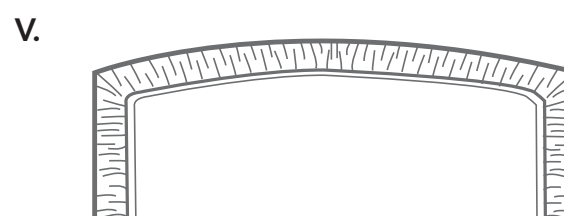
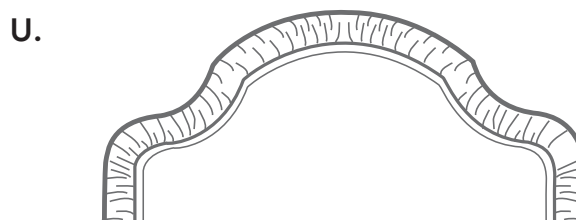
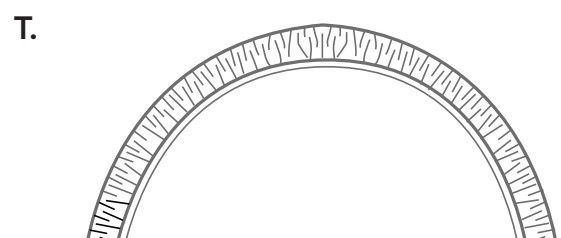
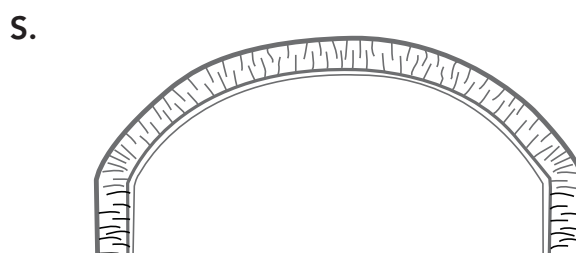
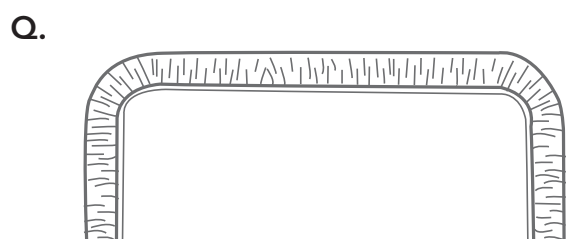
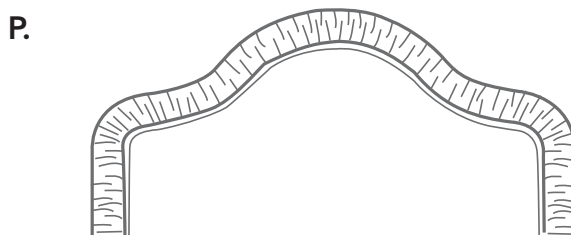
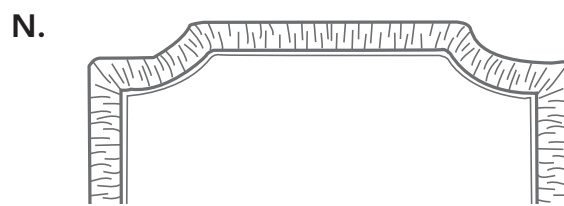
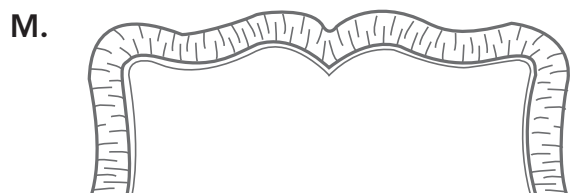
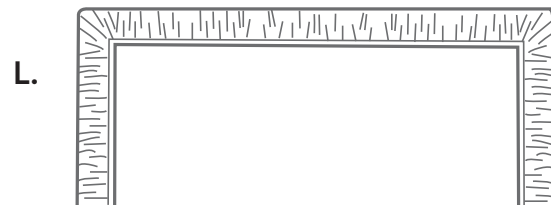
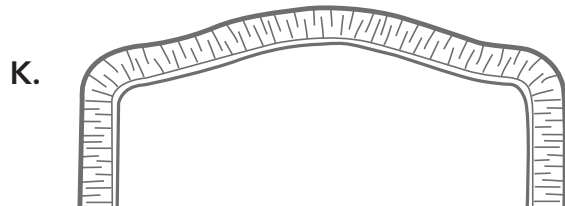

Bedspreads

Filling: Bonded polyester is the standard for commercial bed coverings.

- County's yardage requirements are based on the use of standard 8 oz. fill.
- Other fill weights, such as 6 oz., 10 oz., and 12 oz. are available.

Seams: Fabrics that are 126" wide (based on a 21" drop) are seamless.

- We pre-seam and pattern match all 54" wide fabric prior to quilting.
- All bedspreads are pattern and quilt matched.

Lining: Standard – Pre-shrunk 70/30 polyester/cotton blend, compatible with all face fabrics.

- Upgrade – A high count 56/44 cotton/polyester pre-shrunk lining.
- Additional upcharge options: 100% polyester and colored linings.

Hems: Single-needle hems are lock-stitched through quilting to prevent the spread from unraveling and create a 1" self-welt look.

Finish: All corners are mitered for strength.

Options: Welt cord is available from ¼" to 1" to create a border around the width of the bed's top edge or around the bottom perimeter.

Pillow Tuck: The allowance added to cover the pillow

- Economy – 15"
- Standard – 18"
- Double Stack – 30"
- Reverse Sham – 36"

Measurements: Indicate bed type: Twin, Double, Full, Queen, King, etc.

STANDARD MEASUREMENTS		
	FULL LENGTH BEDSPREAD	COVERLET
Twin	39" x 75" x 21"	39" x 75" x 13"
Twin XL	39" x 80" x 21"	39" x 80" x 13"
Double	54" x 75" x 21"	54" x 75" x 13"
Double XL	54" x 80" x 21"	54" x 75" x 13"
Queen	60" x 80" x 21"	60" x 80" x 13"
Cal King	72" x 80" x 21"	72" x 80" x 13"
Cal King Long	72" x 84" x 21"	72" x 84" x 13"
Dual King	78" x 80" x 21"	78" x 80" x 13"
Eastern King	76" x 80" x 21"	76" x 78" x 13"
Murphy Beds	SUBMIT DIMENSIONS AND REQUEST QUOTE	

Actual measurements, however, will also be requested (width x length x overall height) of bed because of variations in bedding standards. The standard drop from the top of the bed to the floor measures 21". NOTE: Due to increased mattress heights, some bed styles now measure up to 29" or more. Be sure to specify the overall height on all quote requests and orders.



Quilting Patterns

- The quilt patterns are continuous throughout the entire spread.
- The stitches are equal lock-stitches (not chain stitches).
- 8 – 10 stitches per inch.

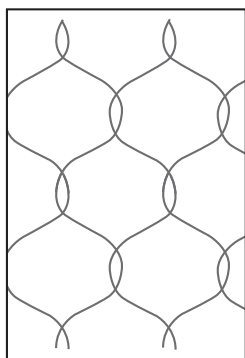

Single Onion (3)

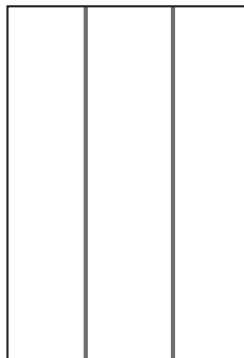

Vertical Channel (4)

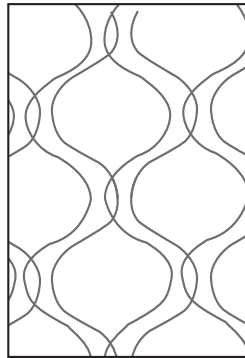

Double Onion (5)

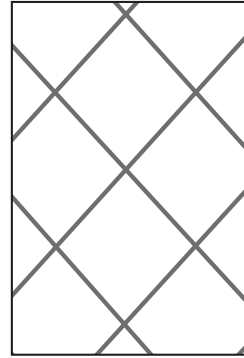

Single Diamond (8)

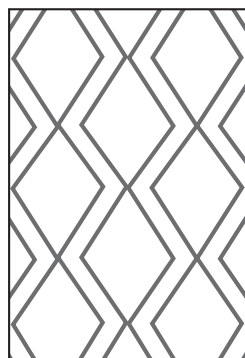

Double Box(10)

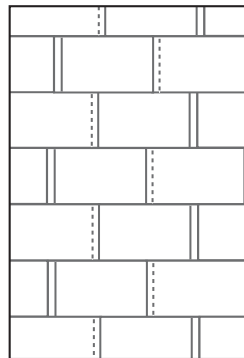

Brick (11)

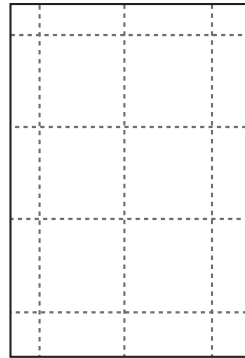

Box (12)

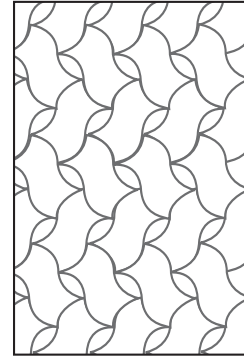

Flag (13)

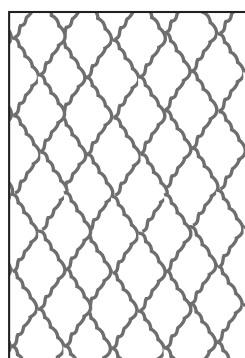

Zig Zag Single
Diamond (14)

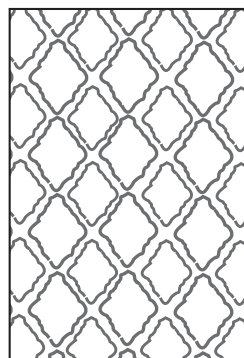

Zig Zag Double
Diamond (15)

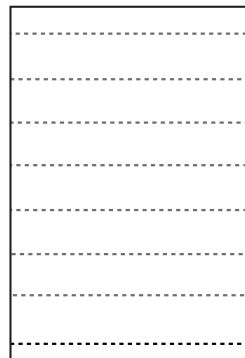

Horizontal Channel (16)

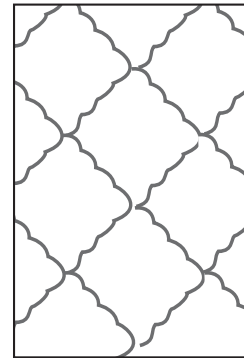

Cloud (17)

If a desired quilt pattern is not found among County's extensive standard selections, consult the factory. County's computerized quilting patterns are produced on machines 135" wide. Every quilt pattern on the market is also available through County.



Bedspread Styles

Standard Bedspread and Coverlet Styles

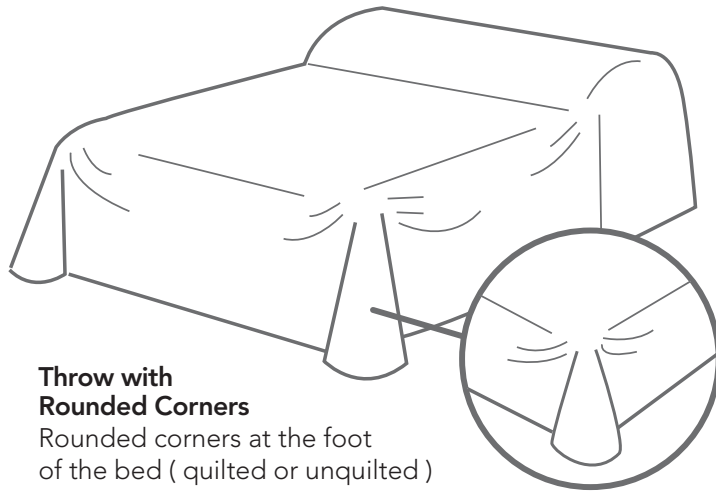

Throw with Rounded Corners

Rounded corners at the foot of the bed (quilted or unquilted)

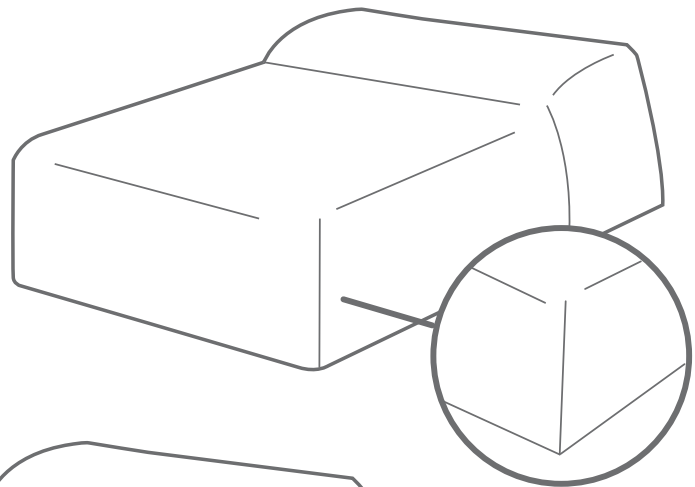

Fitted with Cap Corners

Split corners stitched closed at the foot of the bed (quilted or unquilted)

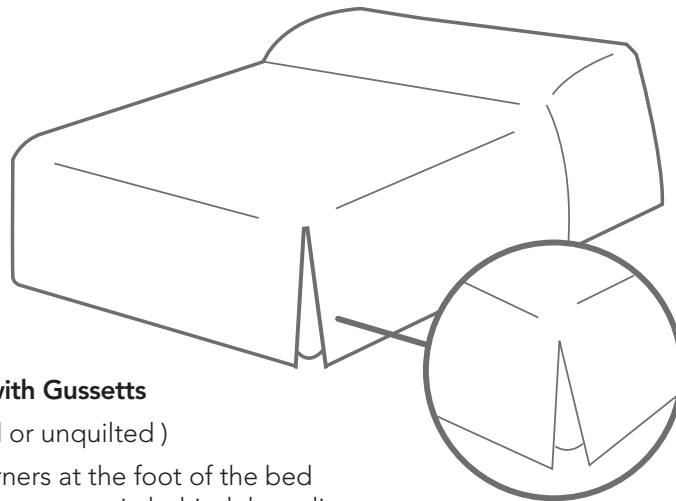

Fitted with Gussetts

(quilted or unquilted)

Split corners at the foot of the bed with gusset sewn in behind the split. The gusset may be quilted or unquilted - unquilted requires an additional 3/4 yard of material.

Fitted with Waterfall Front

The top of the bedspread falls over the end of the bed for the foot drop.
The side drops wrap around the foot of the bed 8 to 12 inches under the foot drop.

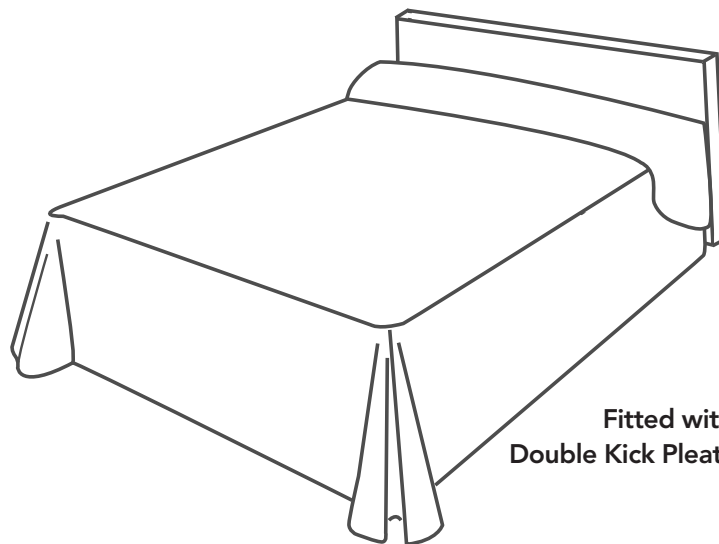
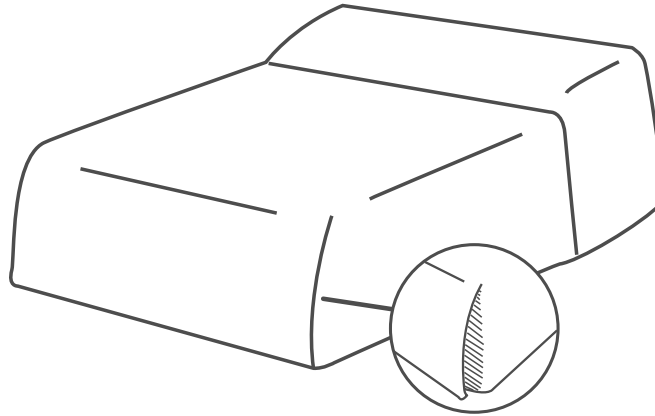

Fitted with Double Kick Pleats

COM Yardage Requirements for Bedspreads

SIZE		BEDSPREAD STYLE					
		Throw w/Rounded Corners, Fitted w/ Closed Corners, Fitted Waterfall		FITTED WITH GUSSETS			
Bed Type	Dimensions			Quilted Gusset	Unquilted Gusset	Quilted Gusset	Unquilted Gusset
		54" wide	126" wide	54" wide	54" wide	126" wide	126" wide
Twin	39" x 75" x 21"	8	2.6	8	8.75	2.6	2.9
Twin XL	39" x 80" x 21"	8	2.6	8	8.75	2.6	2.9
Double	54" x 75" x 21"	8	3.1	8	8.75	3.1	3.5
Double XL	54" x 80" x 21"	8	3.1	8	8.75	3.1	3.5
Queen	60" x 80" x 21"	8-12	3.3	8-12	8.75	3.3	3.7
Cal King	72" x 80" x 21"	12	3.8	12	12.75	3.8	4.1
Cal King Long	72" x 84" x 21"	12	3.8	12	12.75	3.8	4.1
Dual King	78" x 80" x 21"	12	3.8	12	12.75	3.8	4.1
Eastern King	76" x 80" x 21"	12	3.8	12	12.75	3.8	4.1



Coverlets

Coverlet construction techniques and specifications are the same as those noted for quilted bedspreads except that the shorter drop on the sides and foot typically measures 13".

Because the remainder of the bed structure is exposed, showing the box spring, frame and any open area, they are normally used with a bed skirt.

The styles of coverlets are also the same as those mentioned in the Bedspread section:

- Throw with Rounded Corners
- Fitted with Closed Corners
- Fitted with Gussets (quilted or unquilted)
- Fitted with Waterfall Front
- Fitted with Double Kick Pleats

Coverlet Throw with Rounded Corners

(quilted or unquilted)

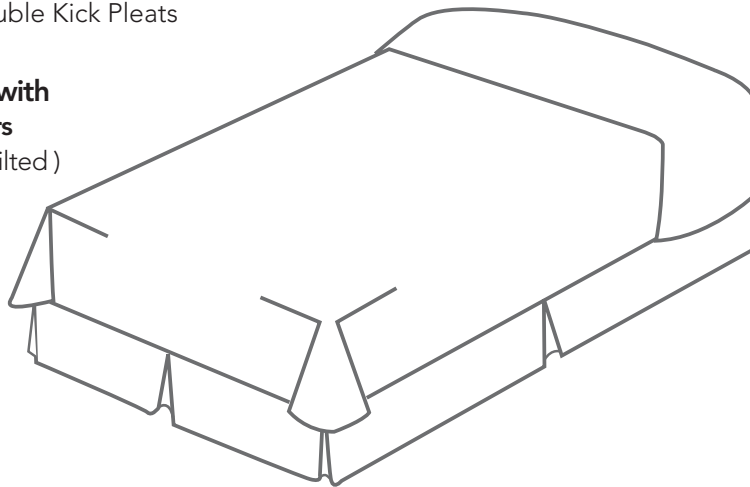

Fitted with Gussetts

(quilted or unquilted)

Split corners at the foot of the bed with gusset sewn in behind the split. The gusset may be quilted or unquilted - unquilted requires an additional 3/4 yard of material.

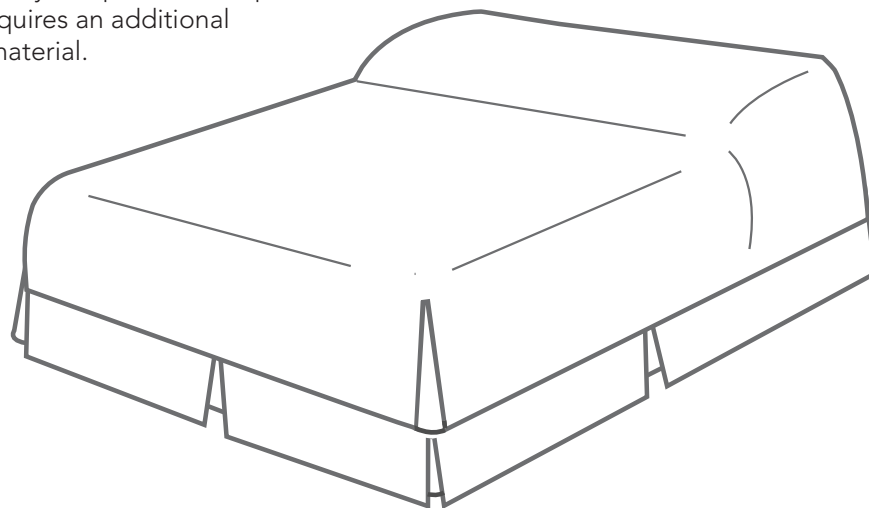

Coverlet Styles

Fitted with Cap Corners

Split corners stitched closed at the foot of the bed (quilted or unquilted)

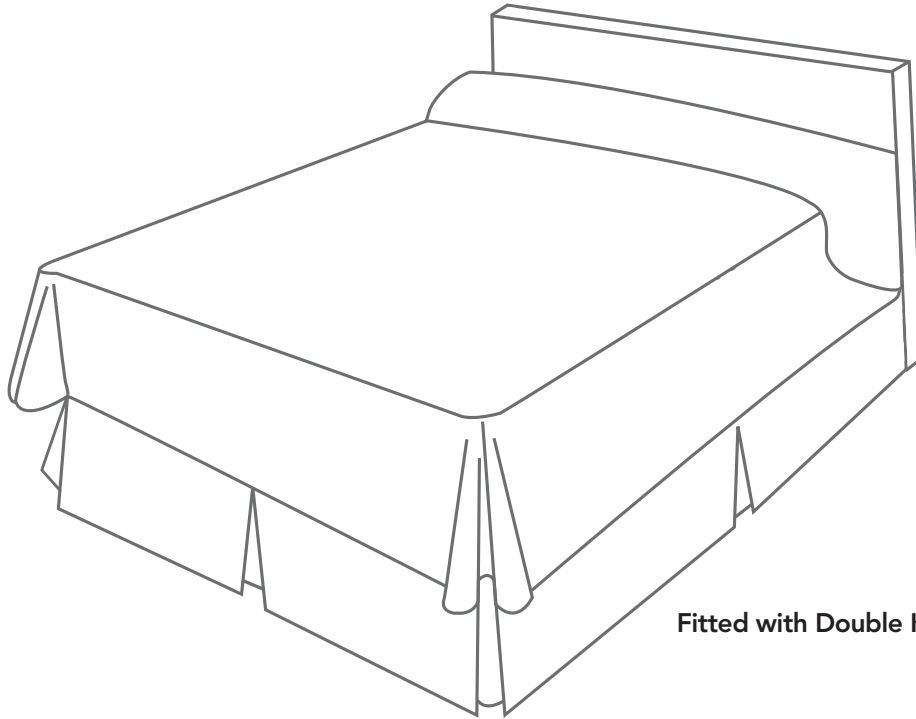
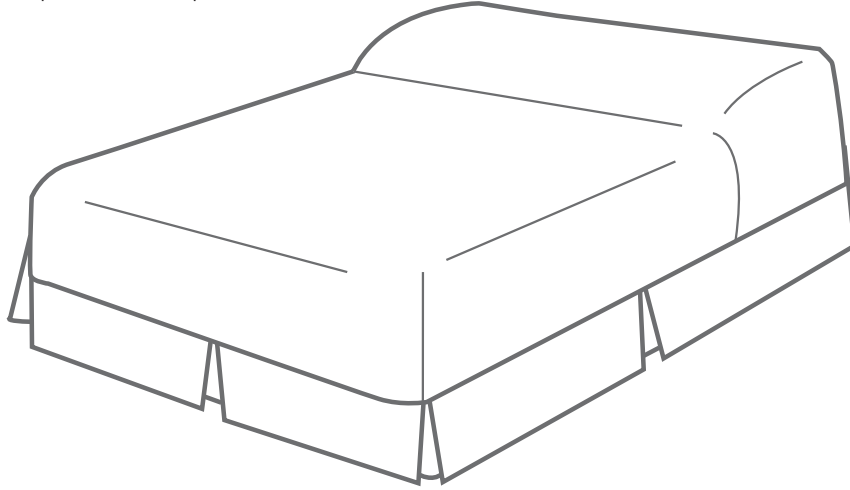

Fitted with Double Kick Pleats



Fitted with Waterfall Front

The top of the bedspread falls over the end of the bed for the foot drop.
The side drops wrap around the foot of the bed 8 to 12 inches under the foot drop.

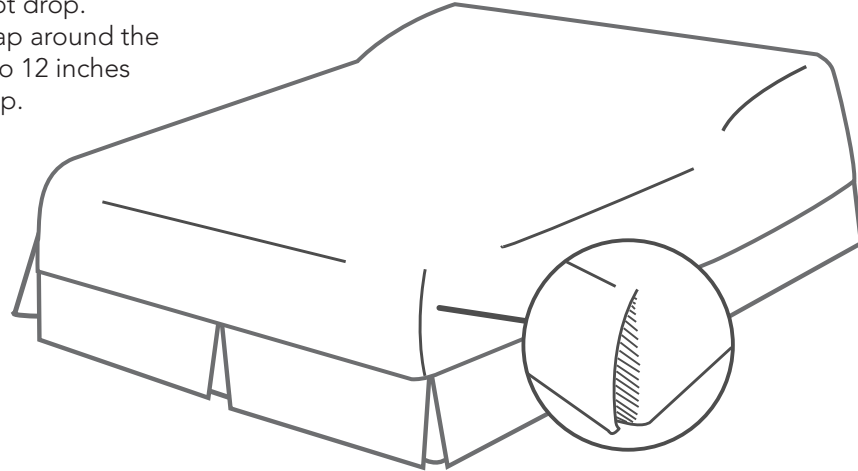

COM Yardage Requirements for Coverlets

SIZE		COVERLET STYLE					
		Throw w/Rounded Corners, Fitted w/ Closed Corners, Fitted Waterfall		FITTED WITH GUSSETS			
Bed Type	Dimensions	54" wide	126" wide	Quilted Gusset	Unquilted Gusset	Quilted Gusset	Unquilted Gusset
		54" wide	126" wide	54" wide	54" wide	126" wide	126" wide
Twin	39" x 75" x 12-13"	7.5	2.2	7.5	8.3	2.2	2.5
Twin XL	39" x 80" x 12-13"	7.5	2.2	7.5	8.3	2.2	2.5
Double	54" x 75" x 12-13"	7.5	2.6	7.5	8.3	2.6	2.9
Double XL	54" x 75" x 12-13"	7.5	2.6	7.5	8.3	2.6	2.9
Queen	60" x 80" x 12-13"	7.5	2.8	7.5	8.3	2.8	3.1
Cal King	72" x 80" x 12-13"	11	3.2	11	11.8	3.2	3.5
Cal King Long	72" x 84" x 12-13"	11	3.2	11	11.8	3.2	3.5
Dual King	78" x 80" x 12-13"	11	3.3	11	11.8	3.3	3.6
Eastern King	76" x 80" x 12-13"	11	3.3	11	11.8	3.3	3.6

Bedding Measurements

Measurements required for quoting and production of duvets, bedspreads, coverlets and bed skirts include:

- Width and length of bed
- Coverlet drop
- Bed Skirt drop

Note: Due to the overlap of the coverlet and bed skirt, the two drops should be greater than the overall height of the bed.

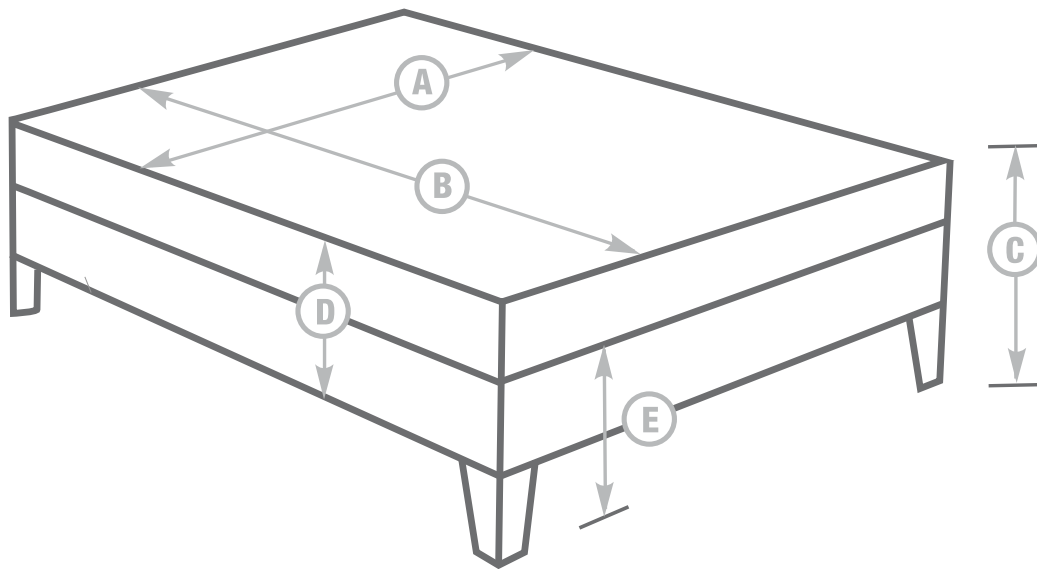

- A - Width of Bed
- B - Length of Bed
- C - Drop from Top of Mattress to Floor
- D - Height from Top of Mattress to Bottom of Box Spring
- E - Distance from Top of Box Spring to Floor

